

LTec THREADED COUPLING STEEL CHUCKS WITH STRAIGHT SHANK - C0110

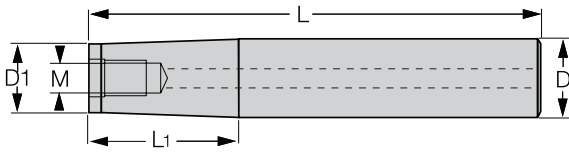

Tech. Code	C01 Euro	Description	D mm	D1 mm	L mm	L1 mm	M mm
C0110166125	181,00	CIL16 M6 L125	16	9.7	125	60	6
C0110208170	197,00	CIL20 M8 L170	20	13	170	66.8	8
C01102510200	197,00	CIL25 M10 L200	25	18	200	57.2	10
C01103212200	222,00	CIL32 M12 L200	32	21		78	12
C01103216230	222,00	CIL32 M16 L230			29	230	50

LTec THREADED COUPLING CARBIDE CHUCKS WITH STRAIGHT SHANK - C3180 - C3184

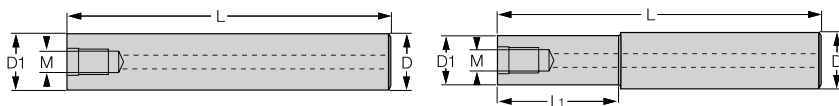

CYLINDRICAL TAPER

Tech. Code	C01 Euro	Description	D mm	L mm	M mm	Image
C318408150	411,00	CIL 16 MD M8 L150	16	50	8	1
C318408200	542,00	CIL 16 MD M8 L200		200		
C318410150	542,00	CIL 20 MD M10 L150	20	150	10	
C318410200	682,00	CIL 20 MD M10 L200		200		
C318412200	1.021,00	CIL 25 MD M12 L200	25	250	12	
C318412250	1.257,00	CIL 25 MD M12 L250				

REDUCED TAPER

Tech. Code	C01 Euro	Description	D mm	D1 mm	L mm	L1 mm	M mm	Image
C318008150	457,00	CIL 16 MDR M8 L150	16	15	150	40	8	2
C318008200	602,00	CIL 16 MDR M8 L200			200			
C318010150	602,00	CIL 20 MDR M10 L150	20	19	150	60	10	
C318010200	758,00	CIL 20 MDR M10 L200			200			

On request, threaded coupling with different dimensions, also available.

ELIXIR OF LONG LIFE

in action on

TOS 1.0/

TOS disc oil skimmers remove quickly any kind of extraneous substance from your emulsions, which will have longer life. TOS disc oil skimmers will make you save money.

More info on our website www.linkspa.it or write an email to laboratorio.fluidi@linkspa.it

CLtec ER 6499 COLLET CHUCKS CYLINDRICAL SHANK DIN 1835A - C3190

FIGURE 1

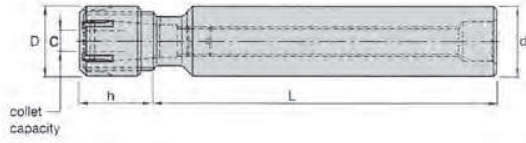
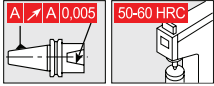
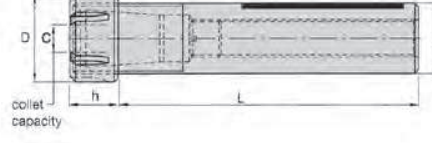

FIGURE 2



Tech. Code	C01 Euro	Description	Capacity	Ring nut	D mm	d mm	L mm	h mm	Figure
C3190111270	93,00	CYL12 x 70 ER11	0.5 - 7	Mini	16	12	70	25	1
C31901116100	103,00	CYL16 x 100 ER11				16	100	22	
C3190161280	93,00	CYL12 x 80 ER16	0.5 - 10		22	12	80	37	
C31901616130	109,00	CYL16 x 130 ER16				16	130		
C3190161680	102,00	CYL16 x 80 ER16				80	30		
C31901620100	105,00	CYL20 x 100 ER16				20		100	
C31901620160	125,00	CYL20 x 160 ER16	1 - 13		28	16	100	40	
C31902016100	106,00	CYL16 x 100 ER20				160	37		
C31902020100	106,00	CYL20 x 100 ER20				20	160	37	
C31902020160	125,00	CYL20 x 160 ER20	2 - 16		42	25	100	46	
C31902520100	117,00	CYL20 x 100 ER25		32					
C31902525100	117,00	CYL25 x 100 ER25	3 - 20	50	32	50	54		
C31903225100	117,00	CYL25 x 100 ER32					38		
C31903232100	117,00	CYL32 x 100 ER32					38		
C3190323250	106,00	CYL32 x 50 ER32	4 - 26	63	40	80	60		
C3190404080	142,00	CYL40 x 80 ER40				80	60		

- COLLETS ER Page C.47

- RING NUTS Page C.63

- WRENCH Page C.69

ETI FLOATING TAPPING CHUCK-CYLINDER COUPLING COMPENSATED- - C3201

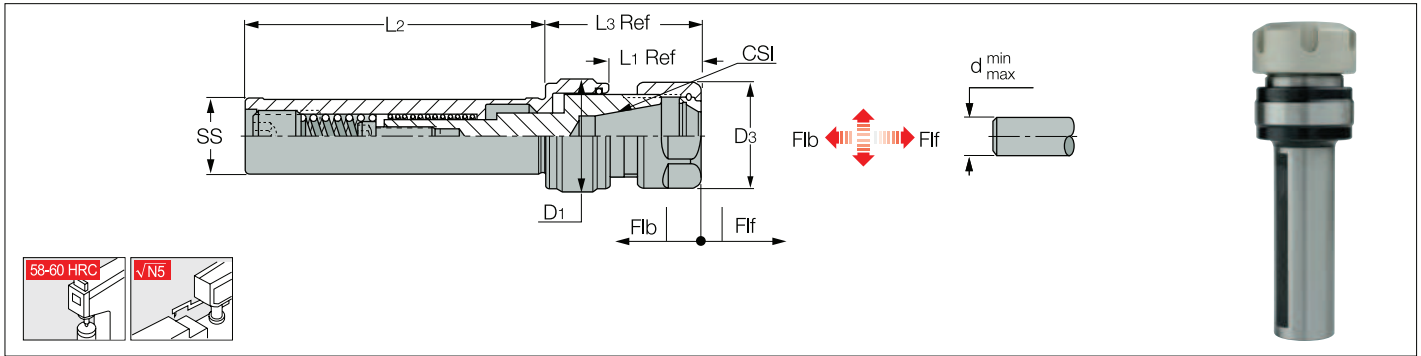

Tech. Code	C01 Euro	Description	SS	Thread	d mm min - max	D3 mm	D1 mm	L1 mm	L3 mm	L2 mm	Flt mm	Flb mm
C3201ER11	395,00	GTI ER11 ST16X150	ST16	M2 - M7	0,5 - 7	16	-	19,00	-	150	6	3
C3201ER16	395,00	GTI ER16 ST20X80	ST20	M3 - M10	0,5 - 10	28	29,5	24,60	41,60	80	8	
C3201ER20	472,00	GTI ER20 ST20X80		M4 - M14	1,0 - 13	34	33,5	28,00	49,00		8	
C3201ER25	552,00	GTI ER25 ST25X80	ST25	M5 - M16	1,0 - 16	42	40,5	32,00	53,00	9		

- RING NUTS Page C.63

- COLLETS ER Page C.47

- WRENCH Page C.69

ETI FLOATING REAMER COLLET CHUCKS - C3205

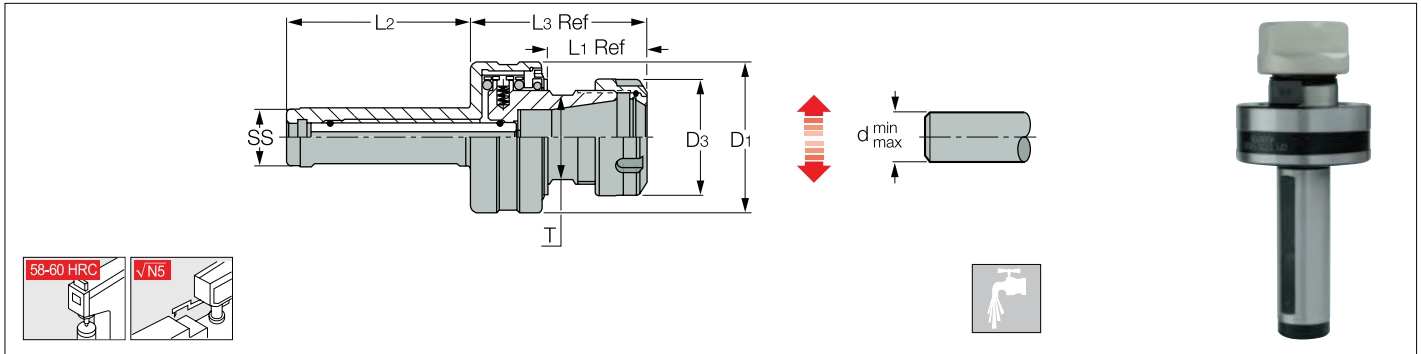

Tech. Code	C01 Euro	Description	SS	C Capacity	L2 mm	L3 mm	L1 mm	D3 mm	D1 mm	T mm
C3205ER20	998,00	GFI ST20 ER20	20	1 - 13	65	55,5	34,5	34	50	22

Radial float 1mm

- RING NUTS Page C.63

- COLLETS ER Page C.47

- WRENCH Page C.69

CLtec DISK SAW HOLDERS DIN 1837-A AND DIN 1838-B - C3230

NEW

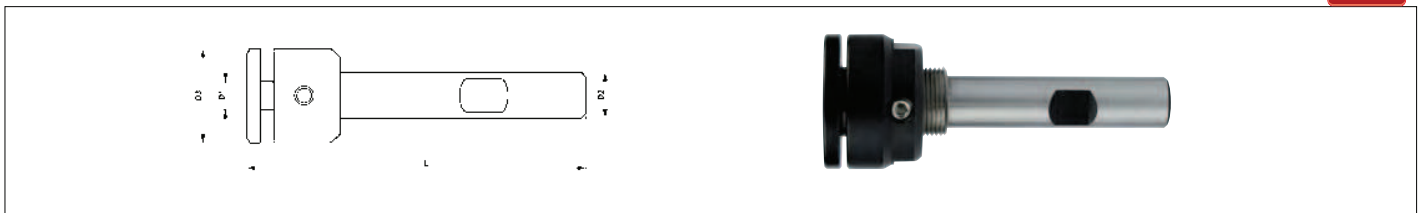

Tech. Code	C01 Euro	D1 mm	D2 mm	D3 mm	L mm
C323005	114,00	5	8	16	60
C323008	107,00	8	6	15	
C323010	107,00	10	8	19	62
C323013	107,00	13	10	24	69
C323016	107,00	16	13	31	78
C323022	114,00	22	16	40	86
C323032	253,00	32	25	88	124